











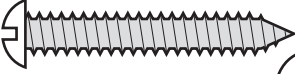
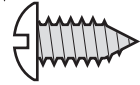

# Closer Instructions

# Instrucciones para el brazo cerrador

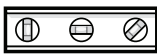
Parts List				Lista de piezas			
Closer Brazo cerrador	Hold Open Washer Arandela para mantener abierto	Door Bracket Soporte de la puerta	Jamb Bracket Soporte de la jamba	#10 x 1-1/2" Screws Tornillos No. 10 x 1-1/2 in. (3,8 cm)	#10 x 5/8" Screws Tornillos No. 10 x 5/8 in. (1,6 cm)	Long Pin Pasador largo	Short Pin Pasador corto
							

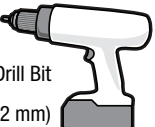
Tools Needed				Herramientas necesarias	
					
			1/8" Drill Bit Broca para taladro de 1/8 de pulgada (3,2 mm)		

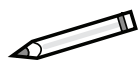
## 1 Pre-load Closer / Pre-cargue el brazo cerrador

Insert hold open washer in place. Inserte la arandela para mantener abierto en su sitio.

Use a screwdriver to pull out closer rod 1/4". Utilice un destornillador para sacar la varilla del brazo cerrador 1/4 in. (6,4 mm).

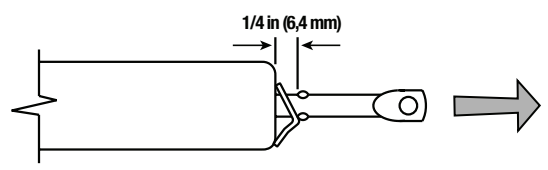

## 2 Closer Locations & Installation / Ubicaciones e instalación de los brazos cerradores

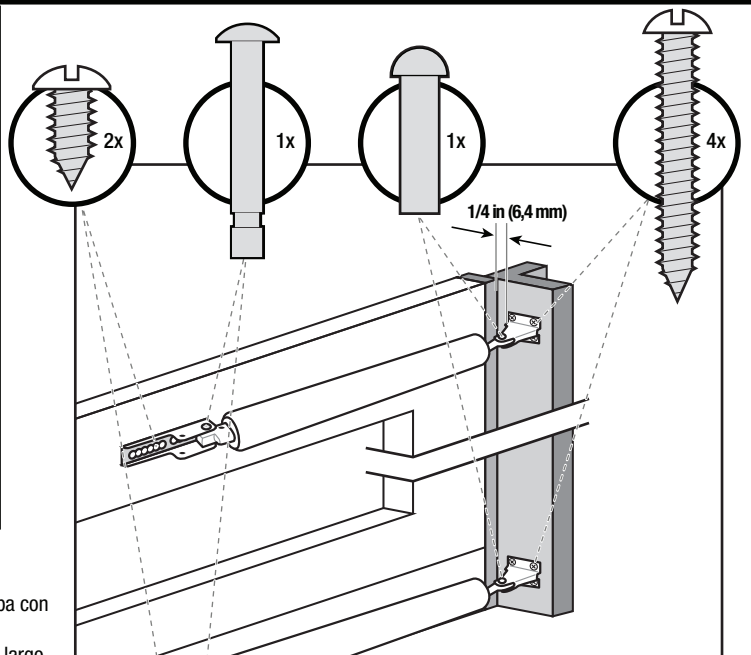
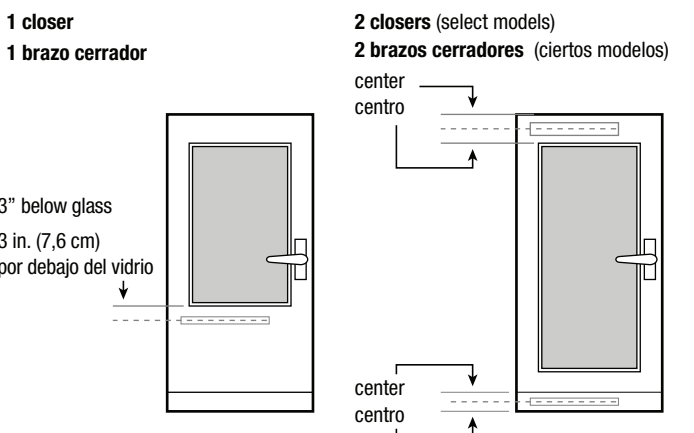

Position closer so as not to interfere with top jamb or drip cap. Coloque el brazo de modo que no interfiera con la jamba superior ni con el canal de goteo

- Drill pilot holes in jamb. • Taladre agujeros guía en la jamba.
- Install screws in jamb. • Coloque los tornillos en la jamba.
- Secure closer to jamb bracket with short pin. • Fije el brazo cerrador al soporte de la jamba con el pasador corto.
- Secure door bracket with long pin. • Fije el soporte de la puerta con el pasador largo.
- Close door. • Cierre la puerta.
- Level and drill 2 pilot holes in door (**Do not drill through door**). • Nivele y taladre 2 agujeros guía en la puerta (**No taladre a través de la puerta**).
- Install door bracket on door with two screws. • Instale el soporte de la puerta en la puerta con dos tornillos.

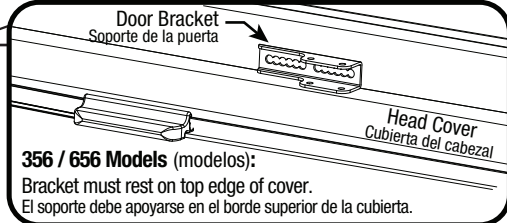

**On ScreenAway® models, do not attach closer bracket to screen head cover.**  
En los modelos ScreenAway®, no fije el brazo cerrador a la cubierta del cabezal de la malla.

## 3 Adjust Closer / Ajuste el brazo cerrador

Turn the adjusting screw to control the speed of the closer. Gire el tornillo de ajuste para controlar la velocidad del brazo cerrador.

To adjust 2 closer models, unhook 1 closer and adjust one at a time. Para ajustar los modelos de 2 brazos cerradores, desenganche 1 brazo cerrador y ajuste uno de cada vez.

